

LBL25 Series

Linear Actuator

Price competitive with Pneumatics yet high cycle rate.

The LBL can be integrated into STACK, manifold for OEM multi-actuator stations.

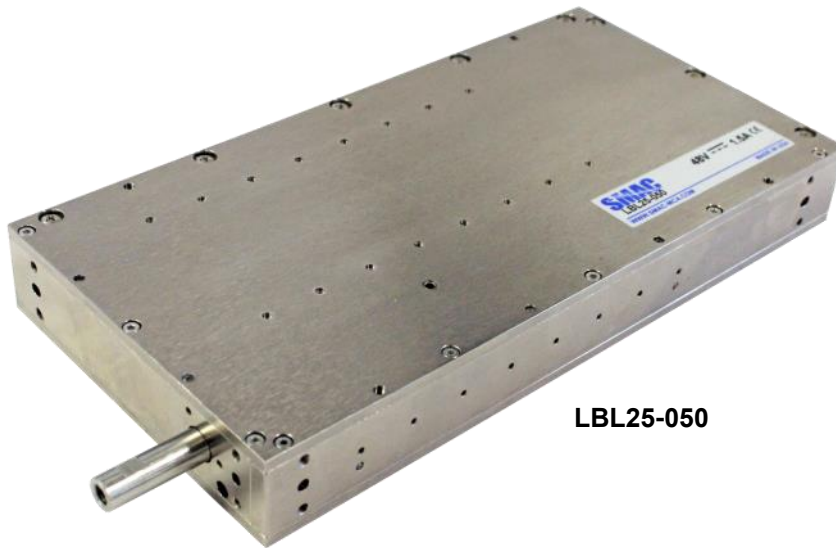

LBL25-050

LBL25 Series

Stroke [mm]	25, 50, 75, 100, 150, 200
Peak Force [N]	45 - 70 (48VDC)
Encoder Resolution [μ m]	5 standard, 1.0 optional

Fully programmable in force, position and velocity
SMAC's Patented 'Soft-Land' technology
Built-in controller type available
The LBL can be stacked for multi-actuator stations, which simplifies mounting and reduces cabling.



LBL25 STACK

Applications

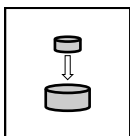

Assembly

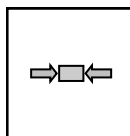

Measuring

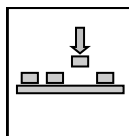

Positioning

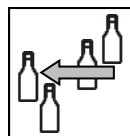

Ejecting

PART NUMBERING

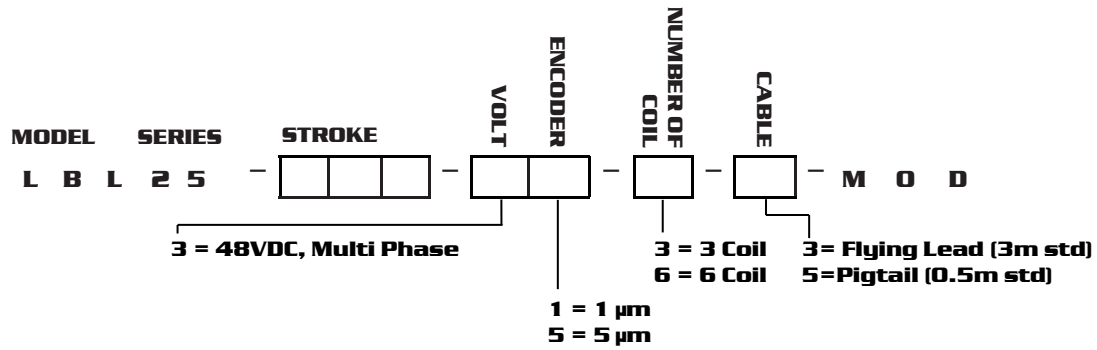

SPECIFICATION

Model	Voltage [DC]	Size: LxWxH [mm]	Stroke [mm]	Peak Force [N]	Force Constant [N/A]	Max. Current [Amp]	Moving Mass [kg]	Weight [kg]
LBL25-025-35-3	48	175x101.6x24.8	25	70	28	2.5	0.14	2
LBL25-025-35-6	48	175x101.6x24.8	25	48	19	6	0.14	2
LBL25-050-35-3	48	200x101.6x25	50	45	18	1.5	0.16	2.2
LBL25-075-35-3	48	240x101.6x25	75	45	18	1.5	0.18	2.22
LBL25-100-35-3	48	280x101.6x24.8	100	45	18	1.7	0.22	3.8
LBL25-150-35-3	48	330x126.6x24.8	150	45	18	1.7	0.22	3.8
LBL25-200-35-3	48	360x126.6x24.8	200	45	18	1.5	0.21	4.56

DIMENSIONS (LBL25-025-35-3 model)

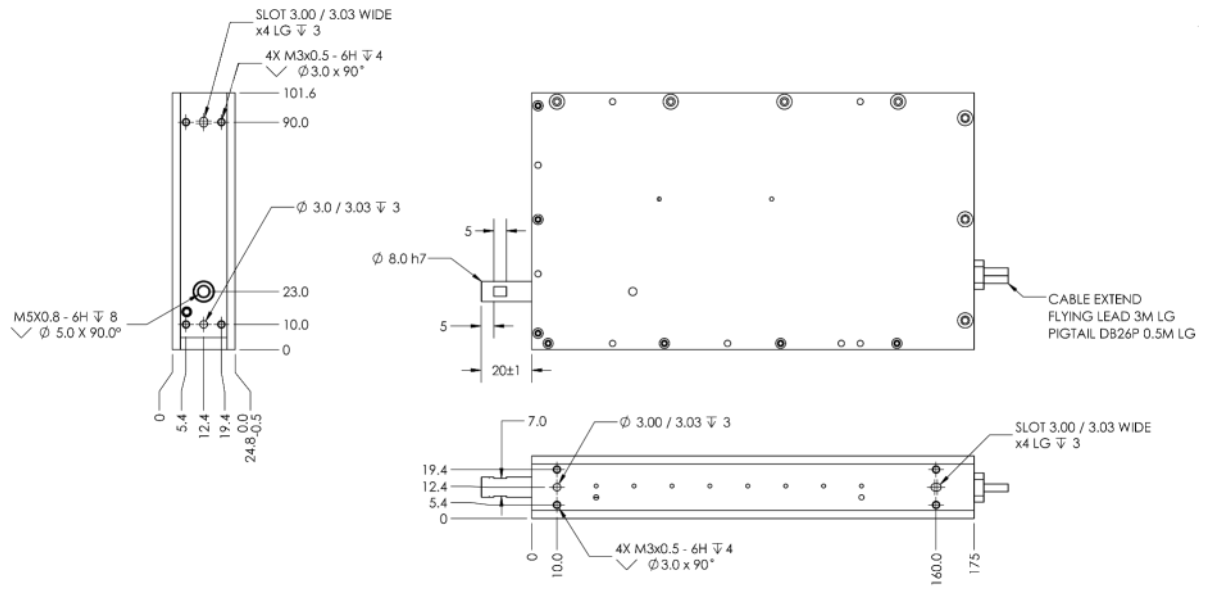

Regional Distributor



5807 Van Allen Way, Carlsbad, CA 92008
 +1 760-929-7575 info@smac-mca.com

Specifications subject to change without notice.
2019 rev.1